



www.dream-go.ipp.pt

Real-time demand response and intelligent direct load control

Second DREAM-GO Workshop

University of Salamanca, Salamanca, Spain, March 20-25, 2017

Microgrid Demonstration Platform: Modbus TCP/IP Connection for Real-Time Monitoring of a Wind Turbine

Filipe Sousa^a, João Spínola^a, Krzysztof Zawislak^b, Pedro Faria^a, Zita Vale^a

^a*GECAD – Research Group on Intelligent Engineering and Computing for Advanced Innovation and Development, Institute of Engineering - Polytechnic of Porto, Porto, Portugal*

^b*Wrocław University of Science and Technology, Wrocław, Poland*

Abstract

Several countries promote wind energy despite their high installation cost, since over time these investments can become profitable. It is important that energy entrepreneurs have up-to-date information of operation parameters, to identify places where excessive energy consumption occurs. For energy management, it is necessary to have an overview of the whole system, such that reporting and further result analysis can be made. With monitoring and control systems, it is possible to enable an improved management of resources, especially in terms of balance between generation and consumption. In this work, it is proposed a graphical interface to monitor and control a wind turbine, in a simulation environment running four operation scenarios.

Keywords: wind turbine emulator, energy monitoring, generation control, modbus protocol

1. Introduction

According to the Coal Industry Advisory Board CIAB, coal fuel represents around 42% of global electricity generation [33]. Many studies report a depleting trend of fossil fuels together with a raise in the concern for the environment. In this context, a lot of countries have started to intensively promote the use of renewable energy sources. The use of renewable energy sources, such as wind and solar can be an advantageous for consumers, since a reduction in energy consumption is made, as well as they become producers in times where generation is higher than consumption. This leads to a new concept in power systems operation, namely, the prosumers.

Since 1997 until 2014 in general, wind power capacity has been growing year by year, with a high contribution of large wind farms built by the national government of many countries. In 2014, the growth in produced energy by wind was almost the same as half of rising global produced electricity, therefore, carbon dioxide emissions remained stable [2]. Reaching the wind power capacity threshold of 50 GW, represented an historical value of capacity for wind energy, clearly underlining a trending path for the use of the distributed energy resources. The following year, 2015, the amount of produced energy went up by 22% reaching around 63 GW. Regarding yearly global energy produced from wind power, around 370 GW in 2014 and 433 GW in 2015, resulted in an 17% increase. This places wind turbine utilization as the most efficient method to produce energy than any other technologies [3]. In 2015, according to the IEA, China led the way with a record of 30.8 GW installed capacity, and until 2016, it had more than 145 GW (more than all of the European union). Considering the high level of implementation regarding wind energy generation, there is the need for systems and tools that can ease the integration of these resources into power

systems, and provide complementary services to it, in a way that operation and energy quality are improved. The applications and advantages that wind energy provides, justify the investment made by several countries, for instance, China with a 100 billion USD in 2014.

The installation of distributed energy resources can guarantee several advantages for the operation of power systems, however, this implies the development of a feedback infrastructure capable of providing the power supply enterprises with the status of several energy quality parameters, such as, voltage level, frequency stability, power factor, amongst others. The current developed technology and accessible prices, allow for these systems to be used in households, and not just in large consumers [34]. Various studies show that how information is presented to the consumer, greatly affects the adoption of energy intelligent measures. For instance, a reduction in home energy use of 4-15% is possible, using home energy displays to simplify the human-machine interaction. This interaction between several agents and devices in a multi-layered grid, is associated to the concept of smart grids.

A smart grid is an electrical grid which includes a variety of operational and energy measures including smart meters, smart appliances, renewable energy resources, and energy efficiency resources. The implementation of the smart grid implies the development of communication infrastructures that complement the monitoring and control systems. Moreover, nowadays the monitoring and control systems are gaining relevance due to the possibilities that these allow for consumption and generation management. In a smaller scale, these infrastructures can also be installed in consumption or generation facilities, in the scope of energy management systems and building automation. In this way, the installation can become costly when considering all the costs that these involve, such as, meters of cable. To overcome this issue, standard communications have been developed based on Internet Protocols, in which devices can communicate between other devices and/or human to transmit information following a given predefined structure.

The present work, proposes a monitoring and control system based on Modbus TCP/IP protocol, for a wind turbine emulator. The system is composed of a web-based display that was developed in a PLC, namely, Saia PCD3.M5560 with a smart Remote Input/Output module (RIO), PCD3.T665. The manufacturer provided the necessary software for the creation of the webpage, Saia® PG5 Controls Suite. The PG5 contains a whole set of tools, which allows the creation of a SCADA system, without the need to use any other software.

2. Monitoring and Control System

The proposed monitoring and control system is built of three main components: remote unit, PLC, and wind turbine emulator. The work developed is related to the creation of a webpage interface in the PLC, for the monitoring and control of the wind turbine emulator. The communication between the remote unit and the PLC is performed using Modbus TCP/IP communication protocol.

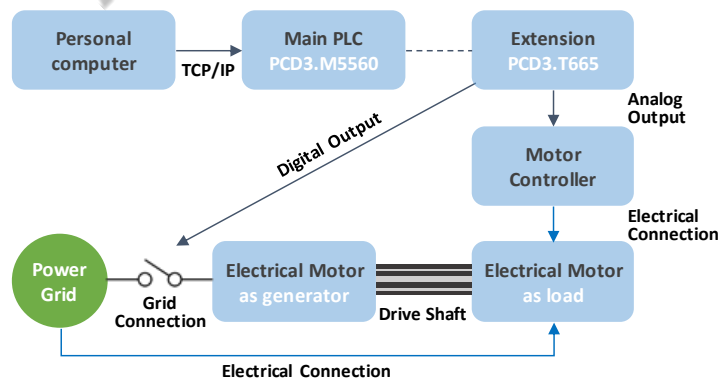

Fig. 1: Proposed system for monitoring and control.

As shown in Fig. 1, the remote-control unit (computer) communicates via TCP/IP protocol, controlling the main PLC and the operation of the motor. The rotor of the motor is connected to the rotor of the generator by common drive shaft. In this way, the wind turbine emulator works considering two electrical motors, that from the grid's perspective, one is acting as load and the other as generator. Mechanical energy

of the motor is transformed by the generator into electrical energy and then synchronized with the main grid to perform coupling of the generator. Apart from controlling the device, the operator is also able to receive data from it. The software, provided by the manufacturer, and TCP/IP standard protocol represent a free starting-point for the development of management, monitoring, and control systems.

To connect PC with main PLC there is the need to configure it using the Saia PG5 Control Suite. In order to do that, it is needed to place the IP address of RIO module in destined place. The main PLC is connected to RIO extra module, which includes additional modules of I/O. In response to messages from the operator, RIO station sets suitable voltage output signals, which are sent to motor controller. The change of voltage value [30] induced in the magnetic circuit of the engine a rotating flux relative to the stator, which rotates the rotor through Foucault currents and Laplace forces. The electrical motor acting as a load is coupled with the electrical motor acting as generator by common drive shaft. The spinning rotor of the electrical motor acting as a load represents the source of mechanical energy used by the electrical motor acting as generator to produce energy, enabling a possible synchronization with the main grid.

3. Applied devices and network

Besides providing control over several devices or applications, a SCADA system is also responsible for the registration of data. In this case, the most relevant data to be monitored corresponds to the electrical energy produced and frequency level. Thus, this system allows for the current status of operation in real-time, graphical analysis of produced energy, as well as, store this data in an excel file. The rest of the data monitored is: voltage between one line and neutral wire, sum of current of three phases, and output voltage of the PLC RIO station. In Saia PG5 Control Suite, namely, in FUPLA editor, it is possible to create logical part of the control process. The FUPLA editor is an application for graphical programming with predefined functions, reducing time in the writing of specific code. Also, WebEditor tool made available by Saia, enables the easy construction of graphic interfaces to help the interaction between the user and the PLC actions. The master PLC is PCD3.M5560, and it was extended by an additional module PCD3.T665 which allows for a centralized control but distributed utilization. All signals controlling the work of the engine are sent from RIO station. The equipment used is described as follows:

- **Saia® PG5 Controls Suite** is a software created by the Swiss company, Saia Burgess Controls AG, to control the PLCs from the same company. The software contains a set of tools, which is required to carry out and operate automation solutions (software and hardware) complemented with the company's instrumentation and control devices. In the software, it is included programming and engineering tools, ready-made libraries, and logic regulation/automation modules. Saia PG5 contains: Project Manager, Network Configurator, Device Configurator, Symbol Editor, Programming Methods, Libs, and WebEditor;
- **Saia® PCD3.M5560** is the master PLC used in the project together with the extension PCD3.T665 Smart RIO module. It can be used either as simple RIO or as intelligent and distributed smart automation stations, capable of executing PG5 user programs;
- **Janitza® UMG 96 RM** is the power analyser that measures the electrical values of the wind turbine emulator's operation. It can measure voltage in TN, TT and IT system schemes. Moreover, other parameters can be obtained, such as, current, power factor, frequency, energy, power, amongst others;
- **Modbus Protocol** simple and robust, it has since become a standard communication protocol, and it is now a commonly available means of connecting industrial electronic devices. Modbus protocol enables communication between many devices (248), connected to the same network. It is very often used to connect prime PC (Master) with remote units (Slave) in SCADA system;
- **FUPLA** is a software created by the Saia Burgess Controls AG to ease the programming of PLC actions, considering the several inputs and outputs available.

4. Wind Emulation Platform

The proposed platform considers a monitoring and control system that enables its user, the possibility to manage the generation injection to the main grid. The operation frequency of the Portuguese power grid, as in other European countries, is established at 50 Hz. For a generator to inject power to the grid, it must

be synchronized with the same frequency. It is considered that the wind turbine only starts to generate after the synchronization with main grid. Thus, the operation of the wind turbine starts at 9.355 V, at 50 Hz (~1500 rpm). From this point on, the increase in frequency leads to a change in the wind turbine, i.e. the wind turbine starts to generate and inject power in the main grid. The maximum value for frequency, being the wind turbine injecting power in the main grid, is around 53.1 Hz (maximum point of simulator work). In Table 1 showed below, illustrates the results measured in the generator mode.

The customer can control the rotational speed of the rotor through the analogue voltage output of the PLC, while the digital voltage output controls the grid connection. The voltage output is in percentage, where a voltage of 9.355 and 10 V, equals 0 and 100%, respectively.

Table 1. Measured results with increasing frequency

Frequency (Hz)	Active Power (W)	Voltage (V)	Current (A)	Rotating Speed (rpm)	Torque (Nm)
50	300	400	2.5	1497	0,56
50.5	0	400	2.7	1505	0.00
51	-100	400	2.7	1509	-2.32
51.5	-220	400	2.8	1515	-3.51
52	-400	400	2.9	1522	-4.50
52.5	-550	400	3.0	1528	-5.45
53	-650	400	3.1	1534	-6.28

The developed graphical interface is presented in Fig.2, and underlines some simplifications for its user. An operator does not have to know what is the lowest value they need to set to initialize the process of energy generation. Also, they do not need to calculate the voltage to achieve a determined level of wind turbine (e.g. 50%). Besides that, for the operator it is also possible to control the work of the device by using the buttons. Pressing the buttons causes an increase or decrease of the percent value about 20 %. No matter how many times the buttons are pressed, there is no chance to overstep them both, bottom value 9.355 V and the top 10 V.

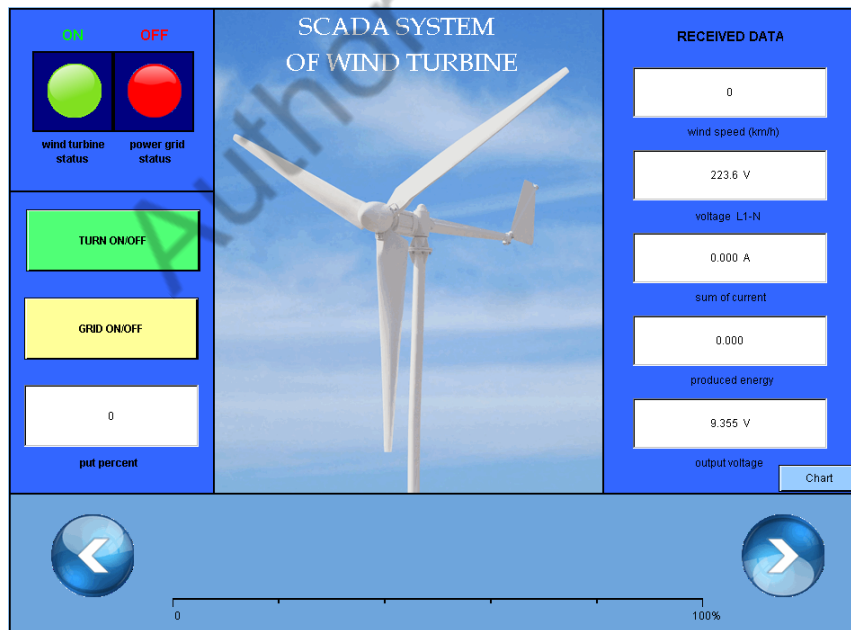

Fig. 2: SCADA system of wind turbine

In real wind turbines, the force that causes the production of energy, is the kinetic energy of the wind. Therefore, apart from the value of the work expressed in percentage, also it is expressed in wind speed. For each voltage value, a corresponding speed (km/h) is known. For values of voltage smaller than 9.355 V, established that there is no influence of wind. Table 2 shows the results. When the operator updates the value in percentage, it receives data, namely, digital output voltage, produced energy, the sum of the current of three lines, and voltage between line L1 and neutral wire. To ease the problem encountered during

development of the FUPLA program, the flowchart presented in Fig. 3 was employed. This part exemplifies applied security system, where there is no possibility to connect the generator to the power grid in a time shorter than 6 seconds, as well as, to not turn off the whole simulator without precedent disconnecting the power grid from the device.

Table 2. Values of analogue outputs with corresponding values of wind speed.

Voltage (V)	Wind Speed (km/h)	Operation Percentage (%)
9.355	0	0
9.420	10	25
9.460	20	50
9.500	22	55
9.560	25	62.5
9.660	30	75
9.780	35	87.5
10.000	40	100

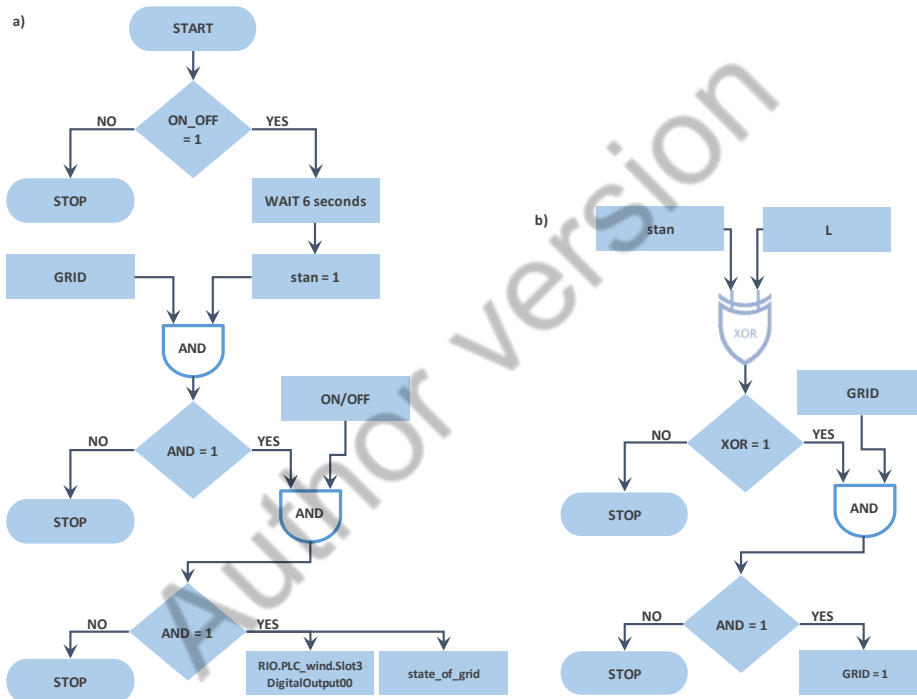

Fig. 3: Flowchart of the security rules for wind turbine operation.

The whole SCADA is segmented into four main sections:

- In the first section, there are lights indicating the present status: wind turbine status and power grid status. Once the wind turbine or grid is on, the lights change their colour from red to green (and vice-versa);-
- The second section, is responsible for changing the settings. When the input “TURN ON/OFF” button is pressed, and there is no value implemented in percentage, the frequency equals 50 Hz. To achieve this value the motor requires a time of 6 seconds, since during this period it is impossible to connect the dynamo to the grid. Only after 6 seconds, one may connect it by pressing the “GRID ON/OFF” button. The whole wind turbine simulator can be turned off only when the grid is turned off beforehand, otherwise, the device may be damaged. To avoid this situation, it is applied a security rule that does not allow the system to turn off the wind turbine emulator without disconnecting the power grid first;
- In the third section, named “RECEIVED DATA”, it is displayed the data obtained from the analyser (Janitza UMG 96 RM). The received data is composed of the following: output voltage, the

produced the energy, the sum of the currents of three lines, and the voltage between line L1 and neutral [37];

- The fourth section of the window is responsible for displaying the values of the bar graph and respective altering buttons. The bar graph is divided into 5 pieces, each 20%.

4.1. Problems Encountered

In the beginning of the project it was assumed that there could be a possibility to change the speed of the rotor by changing both in percentage value of digital output and by wind speed. After many tries to solve this task, it was noticed that it is impossible to accomplish. When the percentage value would be set then it should be displayed with an estimated value of the wind speed. Through this way of thinking, there would be always a mistake when estimating the value.

Implementing into the put percent edit box value f.e. 7%, which is 9.4 V in the output, suits approximately the speed of the wind equals 10 km/h. However, for 10 km/h, that represents 9.42 V, gives a value in percent that equals 10%. And again, the value expressed in percents, points the value in volts, which in a row points the value in km/h. Then the whole situation repeats again- the loop was noticed . Fig. 4 shows that.

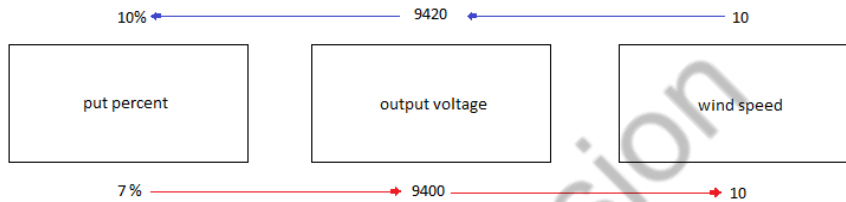

Fig. 4: The mistake perpetrated with initial assumptions.

5. Case Study and Results

On the webpage was possibility to change the wind speed and monitor produced energy in the process. The wind speed was changed in values [km/h]: 0, 10, 20, 22, 25, 30, 35, 40, 35, 30, 25, 22, 20, 10, 0.

In Fig. 5, it is showed a profile of produced energy considering wind speed. In the first second of the process, the generator is not connected to the grid, and no energy is being produced. After the first second, it is shown sudden growth of the value of produced energy to more than 600 W. With growth of the wind speed, there is growth of produced energy. The biggest value of produced energy is for wind speed equal to 40 km/h and corresponds to around 1100 W. After reaching this point, the value of wind speed falls down and the same happens with produced energy. After 8 seconds, the generator is disconnected from the power grid, and consequently turned off (no produced energy).

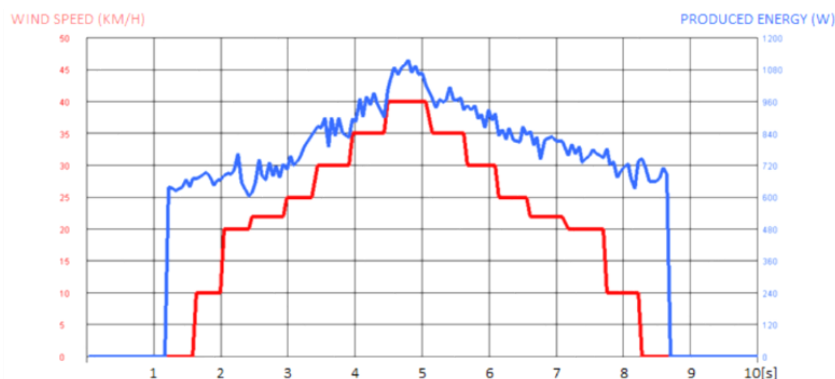

Fig. 5: Energy production profile versus wind speed.

Fig. 6 illustrates the profile of production energy related to a wind speed of 20 km/h. At the beginning of the simulation, the power generator is connected to the power grid, with a produced energy around 750 W. At 400ms, the value of wind speed increases to 20 km/h, raising also the produced energy to nearly 900 W. At these times, it was noticed loss of current.

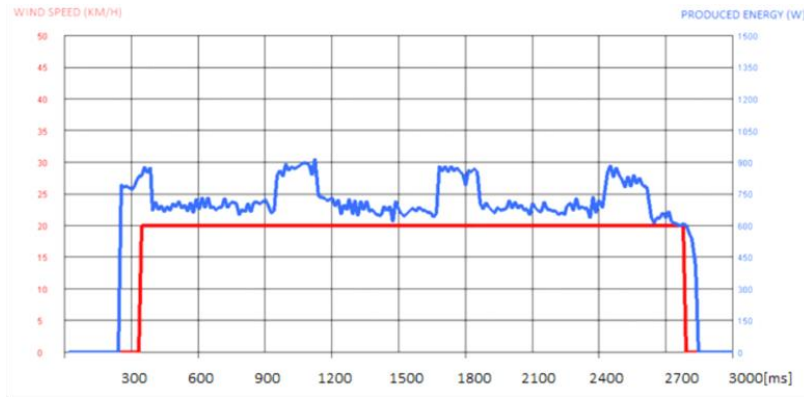

Fig. 6: Energy production profile versus wind speed equal to 20 km/h.

Fig. 7 is analogous to the previous chart and some common observations can be made, however, the value of wind speed this time equals 40 km/h. The difference is in the values of wind speed (max. 40 km/h) and energy produced (max. 1200 W).

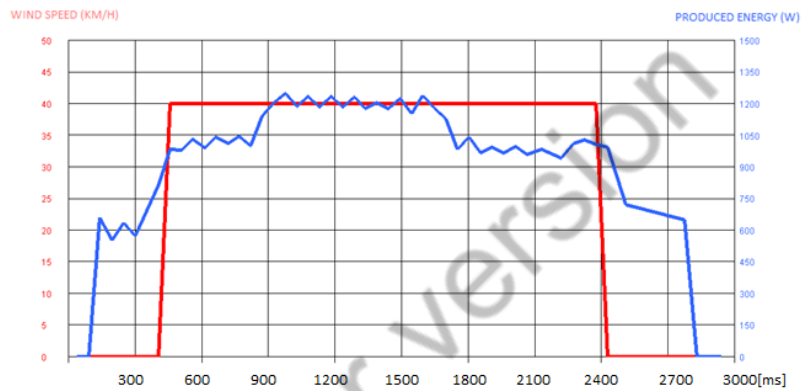

Fig. 7: Energy production profile versus wind speed equal to 40 km/h.

Fig. 8 shows the control process of the wind speed, between the frequency values of 50 Hz and 53.10 Hz. For the second value, energy produced reaches its highest, around 1300 W.

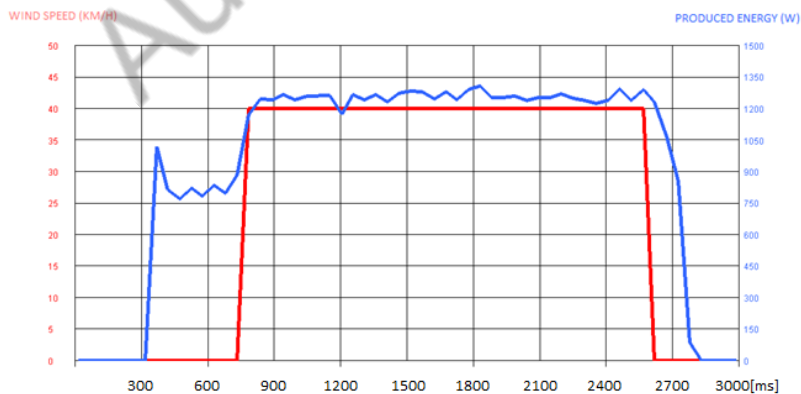

Fig. 8: Energy production profile versus frequency equal to 53.10 Hz.

Based on charts above, it is possible to conclude that with the increase of wind speed, the quantity of energy produced grows. When the simulation time is longer, the results are more accurate, and the highest value of produced energy is attained when frequency equals 53.10 Hz, namely, 1300 W. In the beginning, it was defined that for a frequency value of 50 Hz, the wind speed is zero. When the wind speed equals zero, the produced energy should be equal to zero, however, on charts, it can be seen some values. It explains that it was some inaccuracy in estimating value for wind speed when it equals zero.

6. Conclusions

The SCADA system represents an interesting environment where all editors and configurators can be integrated into one program, and where graphical programming is accessible. Most of the problems occurred not during programming or using WebEditor to create a visualization, but during the configuration of both. An initial assumption of control for the wind turbine was by changing the value in percentage or wind speed. However, it turned out impossible to do both correctly, therefore it was decided that controlling the power using percentage values would simplify the control of the wind turbine. Within the webpage view, there is a light visualization of the wind turbine status and of the connection to the power grid. After pressing the ON/OFF button on the webpage to turn it on, the light changes into a green colour, which means that the electrical engine is ON but effectively the engine can be OFF. The same situation happens with the connection to the power grid. To avoid the situation above, one should send signals to PLC informing about the real status of the wind turbine. The disadvantage of the Saia PG5 Controls Suit software, was that it worked obscurely from time to time. To eliminate compilation errors, it was needed to delete some blocks used in FUPLA editor and put it back again.

This paper can serve for some companies to solve similar problems or to the same systems. GECAD organization can also use it to measure the production of electrical energy by simulating and using it to desirable purposes.

Acknowledgements. The present work was done and funded in the scope of the following projects: H2020 DREAM-GO Project (Marie Skłodowska-Curie grant agreement No 641794); EUREKA - ITEA2 Project SEAS with project number 12004; NETEFFICITY Project (P2020 - 18015); and UID/EEA/00760/2013 funded by FEDER Funds through COMPETE program and by National Funds through FCT.

References

- [1] <http://www.cressall.com/load-banks/ac30-portable-load-bank/>
- [2] GWEC, GLOBAL WIND REPORT ANNUAL MARKET UPDATE 2015, Lauha Fried, Liming Qiao, Steve Sawyer and Shruti Shukla, page 6.
- [3] GWEC, GLOBAL WIND REPORT ANNUAL MARKET UPDATE 2015, Lauha Fried, Liming Qiao, Steve Sawyer and Shruti Shukla, page 4.
- [4] https://www.iea.org/ciab/papers/power_generation_from_coal.pdf, page 15.
- [5] STUDENT LEAFLET EOLYP, page 6.
- [6] Power Analyser UMG 96 RM Basic device: Operating instructions and technical data, <http://www.janitza.com/download-manuals-current-devices.html?file=files/download/manuals/UMG96RM/Basic/Janitza-Manual-UMG96RM-20-250V-en.pdf>, page 90.